

DT15 SPYDER

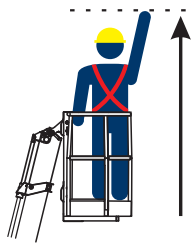

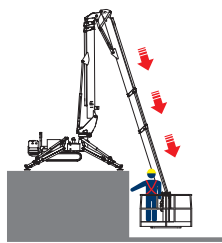

15,00 m



- 2,00 m

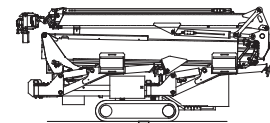

TON

1,55 T

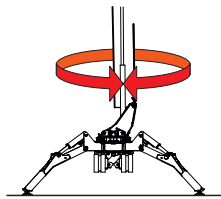

720°

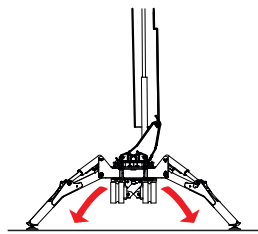

AUTO

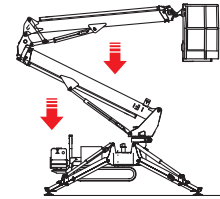

AUTO

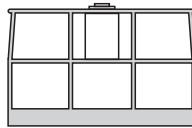
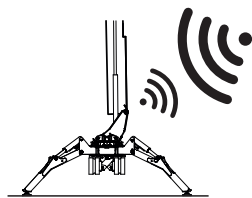

200 KG



ELECTRONIC



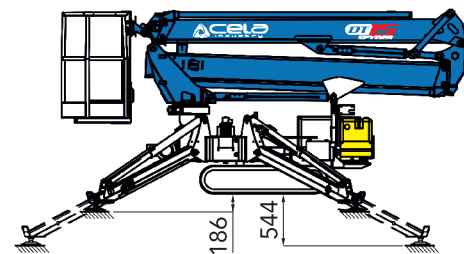
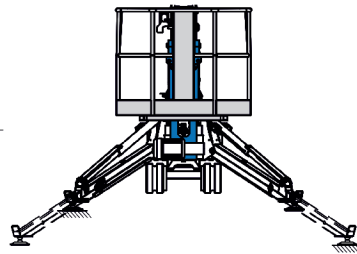
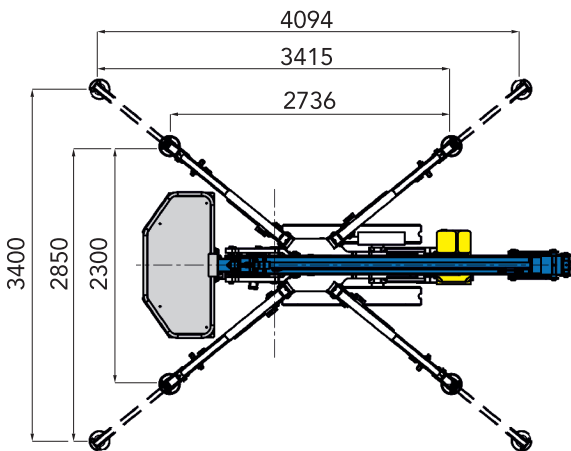
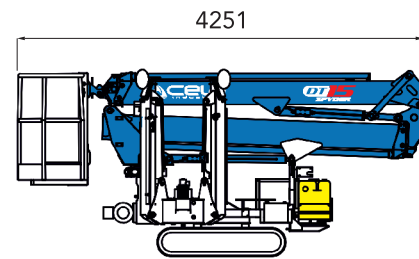
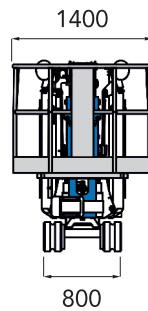
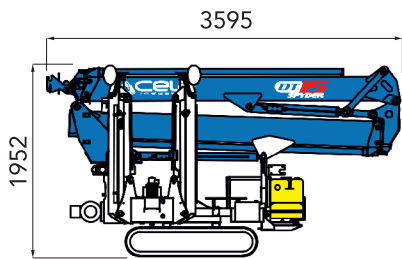
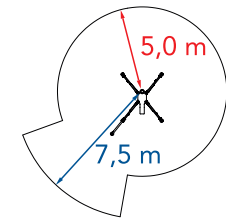
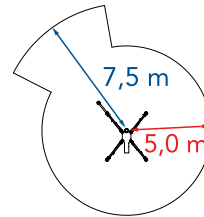
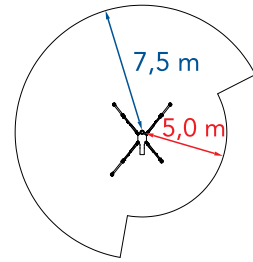
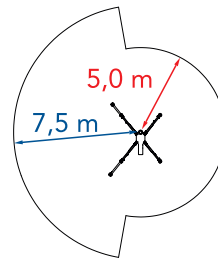
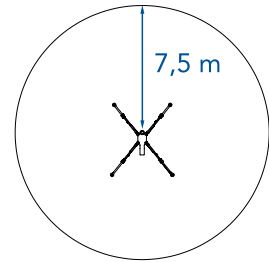
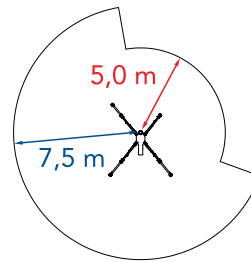
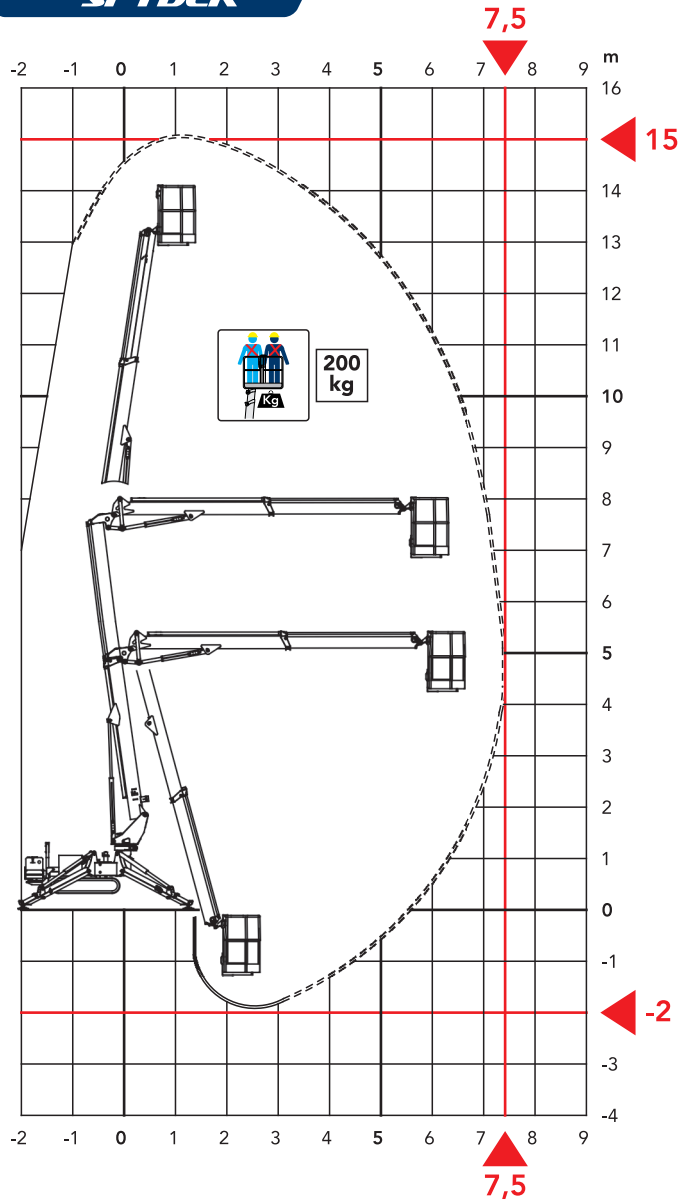

Passiamo sopra ogni cosa
We fly all over

7,5 m →

8,0 m ↑

Sbarco in quota autorizzato
Authorized height landing

Tutto in uno
All in one

0,7 m

00'30"

1,4 m

Come un ascensore
Like an elevator

8,0 m