

# DT28 SPYDER

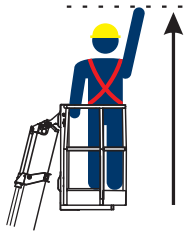

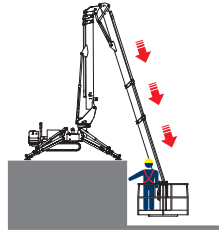

28,00 m



- 6,00 m

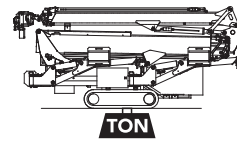

4,90 T

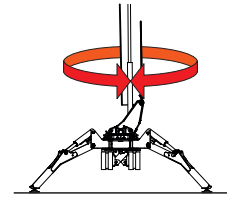

565°

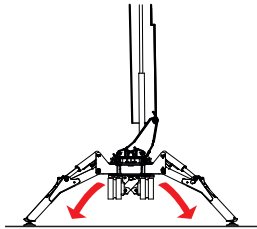

AUTO

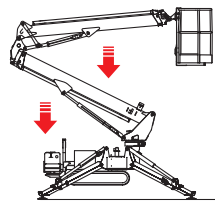

AUTO

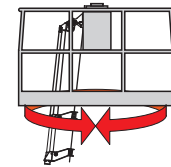
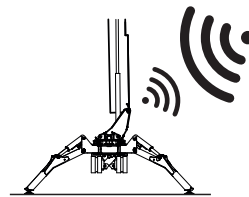

90° + 90°

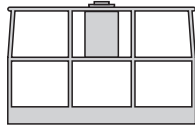

350 KG



390 KG

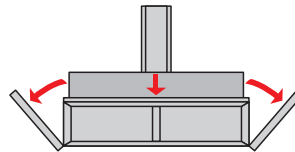

325 KG



ELECTRONIC  
+ RADIO

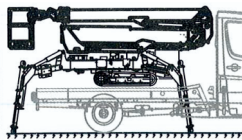

LITHIUM VERSION  
Available



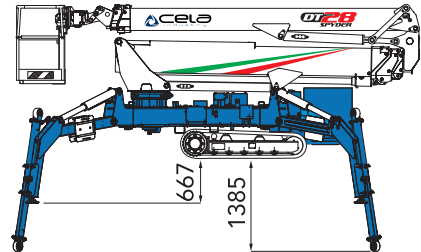
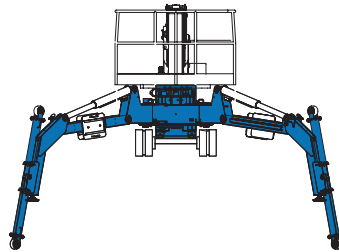
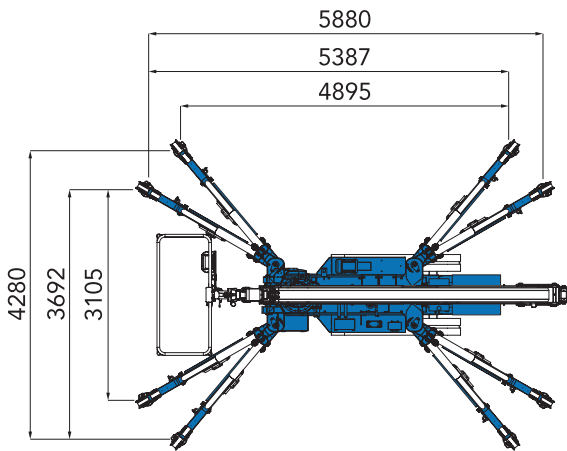
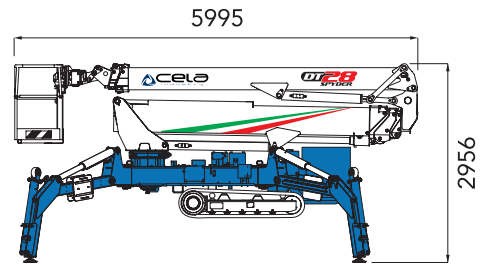
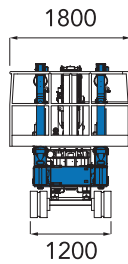
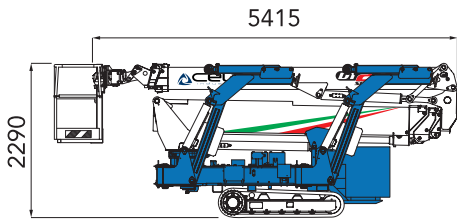
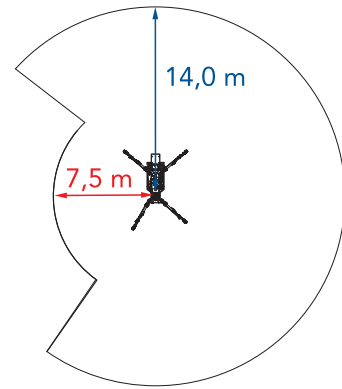
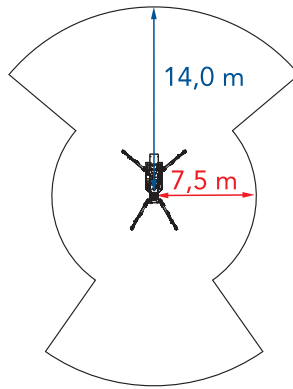
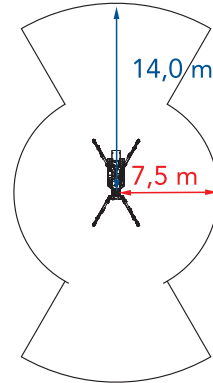
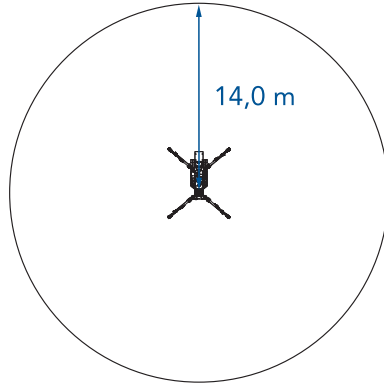
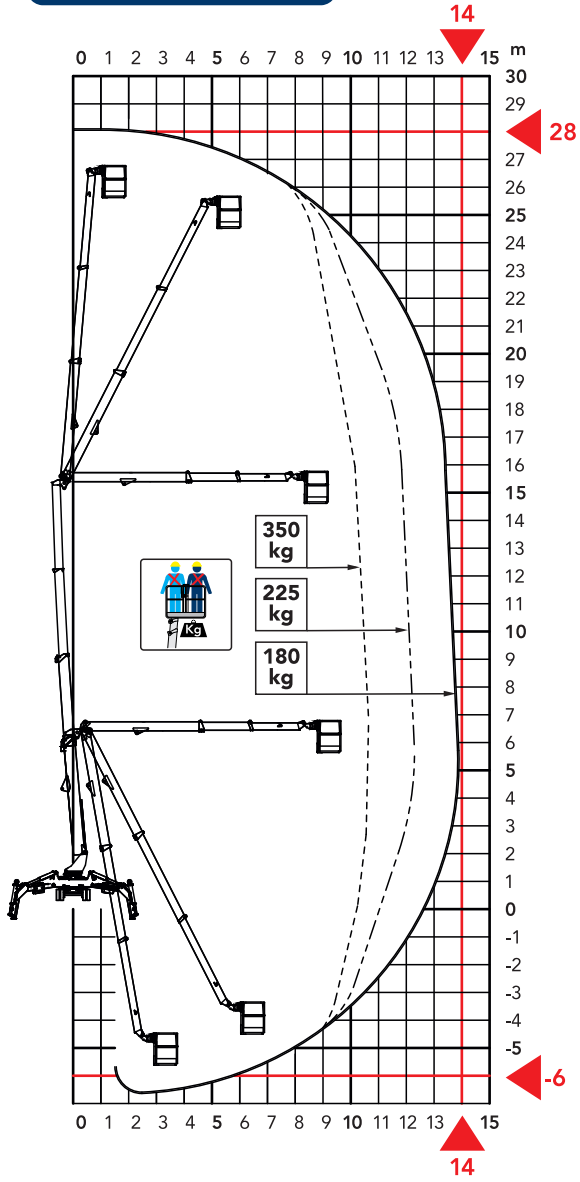





Passiamo sopra ogni cosa  
We fly all over

14,0 m →

16,0 m ↑

Sbarco in quota autorizzato  
Authorized height landing

Tutto in uno  
All in one

0,7 m

1,4 m

1,8 m

2,4 m

00'30"

Come un ascensore  
Like an elevator

16,0 m

